



Hantek



HDG3000C series

Arbitrary waveform signal generator

Quick Guide

2022.05

Warranties and Declarations

Copyright

The copyright of this document belongs to Qingdao Hantek Electronic Co., LTD.

Statement

Qingdao Hantek Electronic Co., Ltd. reserves the right to amend this document without prior notice. Qingdao Hantek Electronic Co., Ltd. promises that the information provided is correct and reliable but does not guarantee that this document is free from errors. Before using this product, please make sure that the specifications of relevant technical documents are the latest effective version. If you use documents or products of Qingdao Hantek Electronic Co., LTD and need products, patents or works of third parties to cooperate with them, you shall be responsible for obtaining the consent and authorization of the third parties. The above consent and authorization shall not be the liability of Hantek.

Product certification

Hantek certified HDG300C-series arbitrary waveform signal generators to meet China's national industry standards and has passed the CE certification.

Contact us

If you have any questions when using the products of Qingdao Hantek Electronic Co., LTD., you can obtain service and support through the following ways:

Email: service@hantek.com, support@hantek.com

Website: <http://www.hantek.com>

1 Safety requirements

1.1 Summary of general safety matters

Read the following safety precautions carefully to avoid injury and to prevent damage to this product or any product connected. To avoid possible dangers, please use this product in accordance with the regulations.

- **Only professionally authorized personnel can perform repairs.**

- **Use the right power cable.**

Use the power cable approved by the country in which the product is used only.

- **Connect and disconnect correctly.**

Before connecting the probe to the circuit being measured, please connect the probe to the oscilloscope first. Before disconnecting the probe from the oscilloscope, please disconnect the probe and the circuit under test first.

- **Ground the product.**

To avoid electric shocks, the product is grounded through a grounding conductor of the power cable. The grounding conductor must be connected to the ground before connecting the input or output terminals of the product. Ensure that the product is properly grounded.

- **Connect the probe properly.**

The ground wire of the probe is the same as the ground potential. Do not connect the ground wire to high voltage.

- **View all terminal rating values.**

To avoid fire or excessive current, please check all rating values and signs on the product. Please consult the product manual for details of the rating values before connecting the product.

- **Do not operate with the cover open.**

Do not run the product with the cover or panel open.

- **Avoid circuit exposure.**

Do not touch exposed connectors and components after power is switched on.

- **Do not operate if the product is suspected to be faulty.**

If you suspect that the product has been damaged, please ask qualified maintenance personnel to check it.

- Maintain proper ventilation.
- Do not operate in a humid environment.
- Do not operate in inflammable or explosive environment.
- Please keep the product surface clean and dry.

**Warning:**

Equipment that meets Class A requirements may not provide adequate protection for broadcast services in residential environments.

1.2 Safety terms and symbols

Safety terms in this manual:

**Dangerous**

Indicates that immediate damage may be caused to you if you perform this operation.

**Warning:**

Indicates that it may not cause immediate damage to you if you perform this operation.

**Note**

Indicates that you may cause damage to this product or other properties if you do so.

Safety terms on the product:

Warning:

Indicates a potential hazard to you if you do not perform this operation.

Safety symbols on the product:



警告



壳体接地端

1.3 Measurement category

Measurement category

This instrument can be used for measurement under class I.



Warning:

This instrument is only allowed to be used in the specified measurement class.

Measurement class definition

- **Class I refers to measurements taken on a circuit not directly connected to the main power supply.** For example, measurements made on circuits that are not exported from a main power supply, especially from a protected (internal) main power supply. In the latter case, the instantaneous stress will change. Therefore, the user should understand the instantaneous capacity of the instrument.
- **Class II refers to measurements taken on a circuit directly connected to low-voltage instruments.** For example, measurements made on household appliances, portable tools, and similar equipment.
- **Class III refers to measurements taken on construction equipment.** For example, measurements made on switchboards, circuit breakers, circuits (including cables, busbars, junction boxes, switches, sockets) in fixed equipment, as well as equipment for industrial use and certain other equipment (for example, fixed motors permanently connected to fixed instruments).
- **Class IV refers to measurements taken at the source of low-voltage equipment.** For example, measurements made on electricity meters, primary overcurrent protection equipment, and pulse control units.

1.4 Working conditions

Temperature

Operating temperature: 0°C - 45°C

Storage temperature: 20°C - 60°C

Humidity

≤+104°F(≤+40°C): relative humidity≤90%

106°F~122°F (+41°C ~50°C): relative humidity≤60%



Warning:

To avoid the danger of short circuit or electric shock, do not operate the instrument in a humid environment.

Altitude

When operating: below 3,000 meters.

When not operating: below 15,000 meters.

Installation (over voltage) Class This product is powered by a main power source that complies with Installation (over voltage) Class II.



Warning:

Make sure that no overvoltage (such as that caused by lightning) reaches the product. Otherwise the operator may be in danger of receiving an electric shock.

Installation (overvoltage) Class definition

Class I refers to the signal level, which is applicable to the measuring terminal of the instrument connected to the source circuit. Measures have been taken to limit the instantaneous voltage to the corresponding low level.

Class II refers to the local distribution level, which is applicable to instruments connected to the mains (AC) supply.

Degree of pollution

Class 2

Pollution level definition

- **Level 1:** No pollution, or only dry non-conductive pollution. This pollution level has no impact. For example: clean room or air-conditioned office environment.
- **Level 2:** Generally, only dry non-conductive pollution. Temporary conduction due to condensation may sometimes occur. For example: general indoor environment.
- **Level 3:** Conductive pollution, or dry non-conductive pollution becoming conductive due to condensation. For example, an outdoor environment with a canopy.
- **Level 4:** Permanent conductive pollution through conductive dust, rain, or snow. For example: outdoor places.

Security level

Level 1 - Grounded products

1.5 Maintenance and cleaning

Maintenance:

Do not make the LCD exposed to direct sunlight for a long time when placing the oscilloscope.

Cleaning:

Regularly check the oscilloscope and probe according to the requirements of the

operating conditions, please follow the following steps to clean the outer surface of the instrument:

- 1) Using a lint-free cloth to remove the dust from the outside of the oscilloscope and probe. Please be careful to avoid scratching the smooth display filter material.
- 2) Using a soft cloth soaked with water to clean the oscilloscope. For more thoroughly clean, use 75% isopropyl alcohol aqueous solvent



Note:

To avoid damage to the oscilloscope or the surface of the probe, please do not use any corrosive reagent or chemical cleaning reagent.



Warning:

Before repowering, please make sure the instrument is completely dry, to avoid electrical short circuit or even personal injury caused by moisture.

1.6 Environmental Precautions

The following sign indicates that this product conforms to the requirements set out by the WEEE Directive 2002/96/EC.



Equipment recycling:

Producing the instrument requires the extraction and use of natural resources. Some substances contained in the instrument may be harmful to the environment or human health if the product is not disposed of properly. To avoid the release of harmful substances into the environment and reduce the use of natural resources, it is recommended that appropriate methods be used to recycle this product to ensure that most of the materials can be correctly reused.

2 Document overview

This document is used to guide the user to quickly understand the front and back panels, user interfaces, and basic operation methods of the HDG3000C-series signal generators.



Tip:

The latest version of this manual can be downloaded at (<http://www.hantek.com>).

Document number:

202205

Software version:

Software upgrade may change or increase product functionalities, please pay attention to Hantek website for the latest version.

Document format conventions:

1 Keys

Use "square brackets + text (bold)" to represent front panel keys, such as **[Utility]** for the "Utility" key.

2 Menu

Use blue menu text (bold) to represent a menu option, for instance, **Basic Settings** indicates clicking the "Basic Settings" option on the current operation interface to enter the configuration menu of "Basic Settings".

3 Operation flow

Use ">" to indicate the next operation, for instance, **[Utility]** > **Store** indicates clicking **[Utility]** and then click the **Store** function key.

4 Knob

Symbol	Knob
	Multi-function knob

Table 2.1 Knob

Document content conventions:

The HDG3000C signal generator contains the following models.

Model	Number of channels	Maximum frequency	CH1/CH2 sampling rate	CH3 sampling rate
HDG3023C	3	25MHz	250MS/s	125MSa/s
HDG3043C	3	40MHz	250MS/s	125MSa/s
HDG3063C	3	60MHz	250MS/s	125MSa/s
HDG3083C	3	80MHz	250MS/s	125MSa/s
HDG3103C	3	100MHz	250MS/s	125MSa/s

Table 2.2 Model

3 **General checking**

Check the shipping package

After receiving the oscilloscope, please follow the following steps to check the instrument: Check whether there is any damage caused by transportation: If the packaging cartons or protective foam pads are seriously damaged, please keep them until the whole machine and accessories pass the electrical and mechanical testing.

Check the accessories

The details of the accessories are provided in Appendix A: Accessories at the end of the user manual. If you find any accessory missing or damaged, please contact the dealer responsible for this business.

Check the machine

If you find the instrument is damaged, not working properly, or unable to pass the performance test, please contact the dealer responsible for this business.

4 Product introduction

HDG3000C series which have function generator, arbitrary waveform generator, pulse generator, harmonic generator, analog/digital modulator, counter and other functions all in one, is an economic, high performance, multifunctional dual channel function/arbitrary wave generator.

4.1 Front panel introduction



Figure 4.1 Front panel

1 Power key

2 Menu keys

3 Function keys

4 CH1/CH2 output keys

5 Channel output switch

6 Direction keys

7 Knob 

8 Numeric keypad

9 LCD

10 Restore default

11 Help

12 USB Host interface

4.2 Rear panel introduction



Figure 4.2 Rear panel

- | | |
|--|--|
| 1 CH1/CH2 Synchronous output end | 5 Counter (0 to 3.3V, external signal input) |
| 2 CH3 Synchronize the output end | 6 USB DEVICE port |
| 3 CH3 output | 7 Safety keyhole |
| 4 10 MHz input/output terminal (10 MHz In/Out) | 8 AC power jack |

4.3 User interface introduction



Figure 4.3 User interface

- | | |
|----------------------|-------------------------|
| 1 Selected channel | 4 Channel configuration |
| 2 Channel parameters | 5 Menu |
| 3 Waveform | |

5 Preparation before use

5.1 Connect the power supply

Connect the power cable as needed.

This series of signal generators can input AC power supply with specifications: 100-120 VAC ($\pm 10\%$), 45-440 Hz or 120-240 VAC ($\pm 10\%$), 45-66Hz. Connect the oscilloscope to the AC power supply using the power cable provided in the accessories.

Turn on the instrument by pressing the power switch in the lower left corner of the front panel. If the instrument is not turned on, verify that the power cable is securely connected and make sure that the instrument is connected to a powered power supply.

Power switch:



To turn off the instrument, press the power switch.



Warning:

To avoid electronic shock, make sure the instrument is properly grounded.

5.2 Adjust the handle

To adjust the handle, hold the handle on both sides of the instrument and pull outward, then rotate the handle.

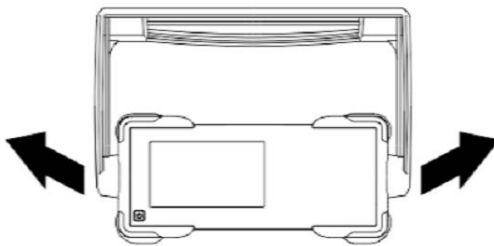

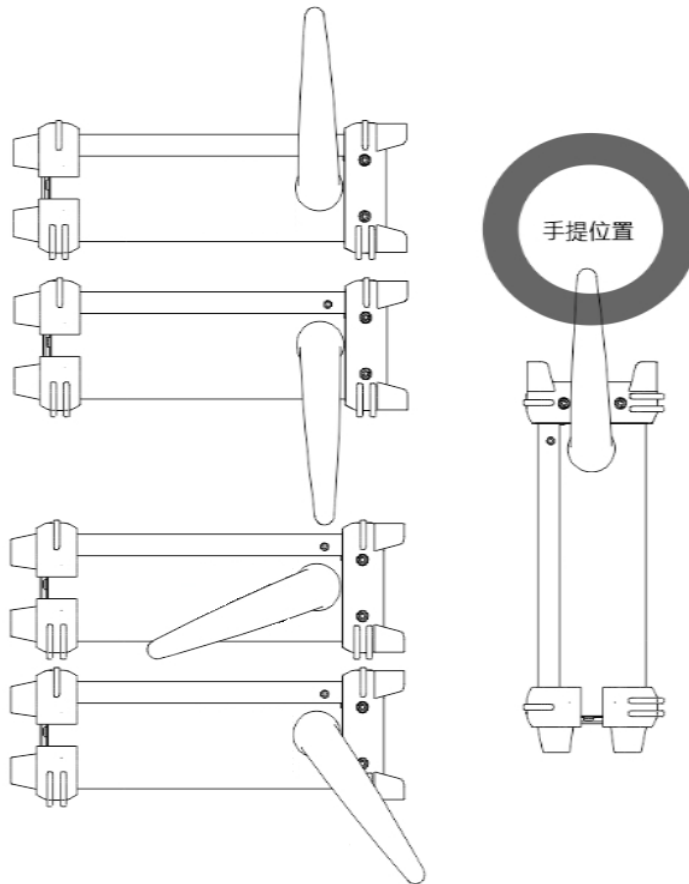



5.3 Set the system language

The signal generator supports Chinese and English, and provides corresponding help information, prompt message and interface display.

Press **[Utility]** > **Language** to select the desired Language. When you select "Chinese" or "English", the menu, help information, prompt message and interface will be displayed in Chinese or English respectively.

6 Use the built-in help system

To get help information for any front panel keys or menu soft keys, first press [?] on the front panel, then press the key you need to get help.

If there is an index for another topic in the content view, the user can turn the knob  to select a different index, press the knob  to access the corresponding topic.

Press [?] again to exit.



7 Parameter setting method

Parameters can be set via the numeric keypad or the knob  with the arrow keys to complete.

7.1 Numeric keypad

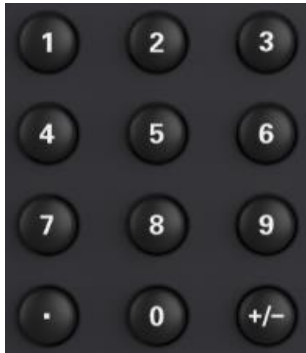

The numeric keypad consists of the following parts:

1. Number keys

Number keys 0 to 9 are used to directly enter the desired parameter values.

2. Decimal point

Press the key to insert a decimal point at the current cursor.

3. Sign key

The sign key "+/-" is used to change the sign of the parameter. When first pressing the key, the sign is "-". When pressing the key again, the sign switches to "+".

7.2 Arrow keys and the knob







Arrow keys:

When inputting parameters, the arrow keys are used to move the cursor to select the currently edited bit.

When editing the file name, the arrow keys are used to move the cursor position.



Knob:

- Under the parameter editable state, rotate the knob  to increase (clockwise) or decrease (counterclockwise) the parameter with the specified step.
- When editing a file name, the knob  can be used to select different characters in the soft keyboard.
- Go to [Wave] > Arb > Type > Custom, the knob  can be used to select different arbitrary wave files.
- When performing Store and Invoke function, the knob  can be used to select where files are saved or select files that need to be read.

8 Remote control

HDG3000C-series signal generators can communicate with computer through the USB interface to achieve remote control. The remote control is implemented based on the SCPI (Standard Commands for Programmable Instruments) command set.

Software installation

Users can download the application software package of the instrument from the official website of Hantek:

<http://hantek.com.cn/products/detail/12267>

Double click the "Setup.exe" file to install according to the installation wizard.

Once the installation is complete, the software icon will be displayed on your computer desktop.

Keysight IO libraries suite installation

Click on the following URL to download the latest Keysight IO Libraries Suite:

<http://www.keysight.com/main/software.jsp?Ckey = 2175637 & lc = chi&cc = CN&nid = - 11143.0.00 & id = 2175637>

Of course, you can download the package from the official website of Hantek.

Double click on the application to start the installation. Follow the installation prompts step by step, and the installation process may take a few minutes.

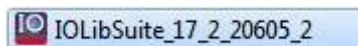

You can see the IO program running in the bottom right corner of the screen after the installation is complete.

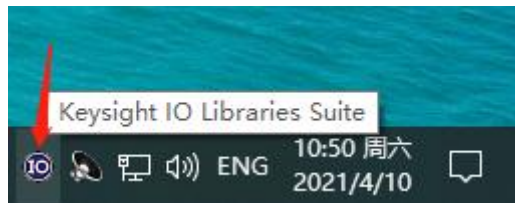

When the instrument is powered on, connect the instrument to the computer via a USB cable. The driver will be installed automatically, and you can see the successful installation prompt, as shown in the picture below:

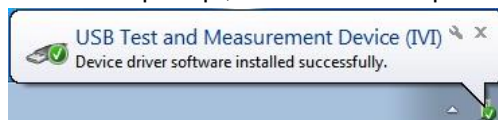

After the driver is installed successfully, you can see the driver information in the Computer Management:

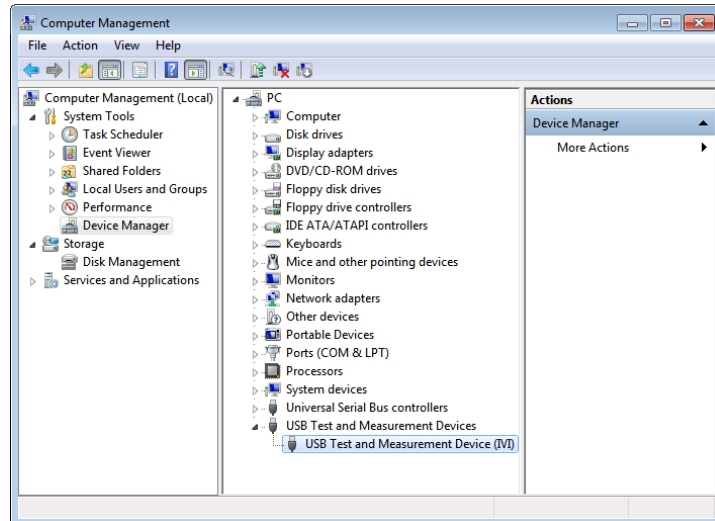

Right click the Keysight IO libraries suite icon in the lower right corner and select "Connection Expert" to see the normal device information:

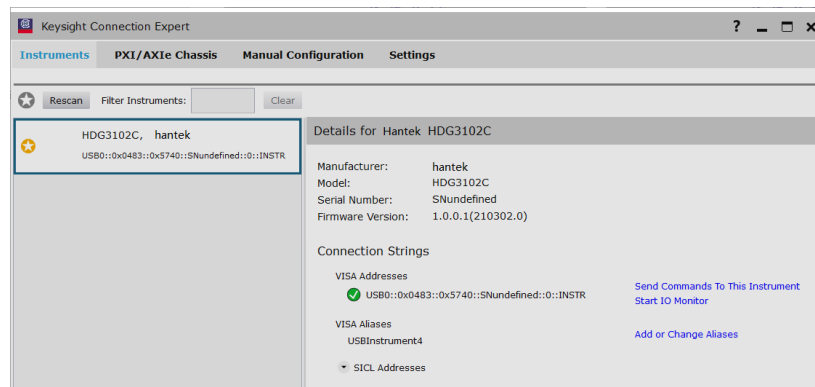

If the driver automatic installation is not successful, right click -> update driver to install manually, select C:\Program Files\IVI Foundation\VISA\IVI USB Staging\ B841AA80 \Windows as the driver path.

Double click on the "HDG-XXXX" desktop shortcut to open the software. If connected successfully, you can see the "Connected" prompt in the bottom left status bar.

Computer side user interface

Double click the software program icon on your desktop and you can see the user interface as follows:

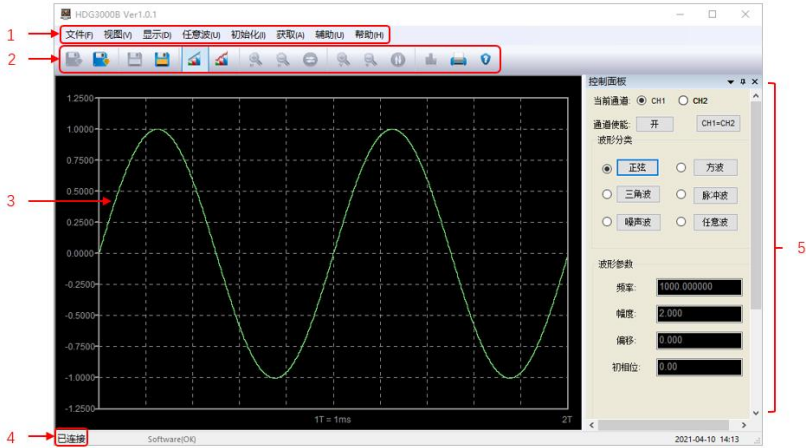

- 1 Menu bar
- 2 Toolbar
- 3 Waveform

- 4 Connection status
- 5 Control bar

9 More product information

1 Get system information about the product

Press **[Utility]** > **Information** to obtain device information, including device model, device serial number, and software version number.

2 View information and installation of the optional items

For more information about this product, please refer to the relevant manual (you can download it on Hantek's official website (<http://www.hantek.com>)).

- HDG3000C User Manual: Provide the function introduction and operation method, remote control method, possible faults and handling methods during use, performance indicators and order information.
- HDG3000C Programming Manual: Provide the SCPI command set and programming examples.
- HDG3000C Data Manual: Provide the main features and technical specifications of the product.



Addr: #35 Building, No. 780 Baoyuan Road, High-tech Zone, Qingdao, Shandong, China 266114

Switchboard: 400-036-7077

Email: service@hantek.com

Tel: (0086)532-55678770 & 55678772 & 55678773

Zip code: 266114

Website: www.hantek.com

Qingdao Hantek Electronic Co., LTD